

TIBO HE - 553CCW

550 - LED 115 W



- **Type:** Profile spot
- **Source:** LED 115 W
- **Optics:** 30° to 45° zoom
15° to 35° configuration possible
- **Colour temperature:** Cool White
- **Standard:** 110 V North american

Profile spot

A High Efficiency LED engine housed within a compact and versatile profile

Tibo HE 553 is a product evolution of the original 75 W LED Tibo 533 model. Tibo HE (High Efficiency) is a new mighty compact profile spot featuring a 115 W white LED engine. It offers twice as much light output and quality. Tibo HE delivers a very high CRI and guarantees a light output that exceeds a 2500 W tungsten luminaire equipped with CTB filter. The power supply is now integrated into the unit to make it really compact and easier to incorporate into a design vision. Its versatile optical design remains unchanged and still offers two different zoom ranges in one single unit – from 15/35° to 30/45° - which makes Tibo HE fitting into any application, from architectural to event applications as well as traditional entertainment lighting.

Features

- **Shutter gate:** 4 shutters. Remove shutters for easy maintenance or tuck fully inside gate for secure transport
- **Universal gobo holder:** m-size, glass and metal gobos
- **Continuous 360° rotation of the fixture:** adjustment of the projected image is always possible
- **Adjustable response time:** choice of fast or slow dimming for tungsten-like simulation - adjustment by DMX protocol
- **Universal data control:** compatible with DMX, RDM, Art-Net, sACN protocols
- **Remote setup:** all parameters can be adjusted by RDM protocol or by web interface
- **PWM adjustment:** choice of different PWM dimming frequencies - continuous mode available
- **DMX:** 8 or 16 bit dimming and strobe function
- **Dimming parameters:** choice of square or linear dimming curves
- **Tilt reference on hanging yoke:** index for rapid re-positioning

Optical

- **Long life:** outstanding operational lifetime expectation, no need to replace lamps, low maintenance
- **Efficient fixture:** up to 70 lm/W
- **Coated double condenser optical system:** ensures optimal light transmission
- **Variable zoom optics:** sharp focus at every beam angle. Independent control of image size and focus. Focus handles on both sides
- **Two different zoom ranges in one single unit:** 30/45° or 15/35° by adding/removing one lens - save on material costs and storage of separate lens tubes
- **Electronic dimmer:** dimming without clipping or cut-out at low intensity levels; high quality smoothing
- **No colour shift:** colour temperature remains the same when dimming

Construction

- **Made in France :** fully manufactured in Robert Juliat premises retaining complete control over all aspects of quality
- **PSU:** built-in electronic flicker-free power supply for easy, plug-and-play installation
- **Power connectors:** neutriK® powerCON TRUE1 TOP IN and OUT connectors for daisy chaining
- **Silent-running cooling fans:** ideal for TV studios and opera houses
- **Electronic thermal management system:** ensures maximum performance of the system without any risk of overheating
- **Bodywork:** die cast aluminium housing
- **Captive knobs and handles:** additional security when working at height or in transit
- **Easy access to all lenses without tool:** easy cleaning of all lenses (including into the lamp house)

Picture:553

DSEN368_553CCW - 05/06/2023

Robert Juliat reserves the right to change or alter any of the items detailed on this page, to increase or improve manufacturing techniques without prior notice.

Robert Juliat S.A.S., 32 rue de Beaumont, 60530 Fresnoy-en-Thelle - France
Telephone : +33 (0)3 44 26 51 89 - info@robertjuliat.fr - www.robertjuliat.com



ROBERT JULIAT

Source (Light quality report(s) available at the end of the document)

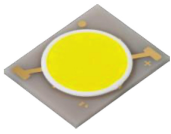

- **Lamp type:** LED
- **Power:** 115 W

LED specifications	Power *	Lumen output*	Colour temperature*	CRI*
LED 115W CW	115 W	14 300 lm	5700K	93

(*) manufacturer's data

Optics

Characteristics

- **Type:** Zoom
- **Beam range:** 30° to 45°
15° to 35° configuration possible
- **Focal length:** 69 - 98 mm

Gel filter

- **Shape:** Square
- **Standard size:** 138x138 mm (5.4x5.4 in)

Gobo

- **Size:** M
- **Material:** Metal
Glass

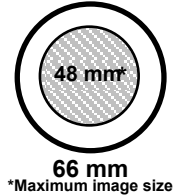

Photometrics (Photometrics report(s) available at the end of the document)

optics: 30°-45° / Standard

• **Optics @ 30°**

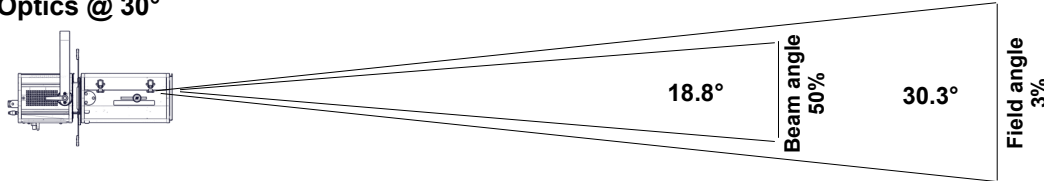

Beam intensity
76 200 cd

Field lumens
8 420 lm

Efficacy
65 lm/W

Distance	3 m	5 m	7 m	10 m	12 m	15 m
Diameter	1.6 m	2.7 m	3.8 m	5.4 m	6.5 m	8.1 m
Illumination	8 500 lux	3 050 lux	1 600 lux	770 lux	530 lux	340 lux
Distance	10 ft	15 ft	25 ft	35 ft	40 ft	50 ft
Diameter	5.4 ft	8.1 ft	13.5 ft	19 ft	21.7 ft	27.1 ft
Illumination	770 fc	340 fc	130 fc	65 fc	48 fc	31 fc

• **Optics @ 45°**

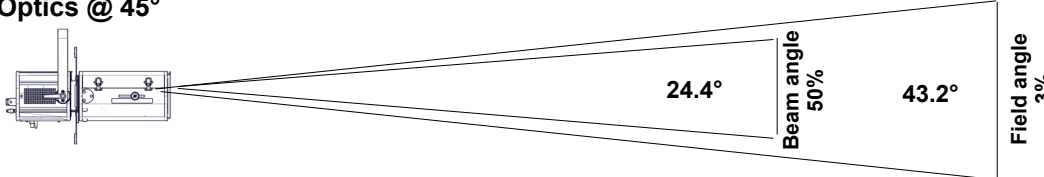

Beam intensity
48 300 cd

Field lumens
9 420 lm

Efficacy
72 lm/W

Distance	3 m	5 m	7 m	10 m	12 m	15 m
Diameter	2.4 m	4 m	5.5 m	7.9 m	9.5 m	11.9 m
Illumination	5 400 lux	1 950 lux	990 lux	490 lux	340 lux	220 lux
Distance	10 ft	15 ft	25 ft	35 ft	40 ft	50 ft
Diameter	7.9 ft	11.9 ft	19.8 ft	27.7 ft	31.7 ft	39.6 ft
Illumination	490 fc	220 fc	80 fc	40 fc	31 fc	20 fc

Remote control

- **Data protocol:** USITT DMX512-A
RDM / Art-Net / sACN

- **Data IN connector:** 5 pins XLR mâle + etherCON RJ45
- **Data OUT connector** 5 pins XLR femelle



• **DMX chart:**

Mode 1 (1 channels)	Mode 2 (2 channels)	Mode 3 (5 channels)	Mode 4 (6 channels)
Dimmer	Dimmer Dimmer fine	Dimmer Strobe duration Strobe speed Response time Control mode	Dimmer Dimmer fine Strobe duration Strobe speed Response time Control mode

Dimensions and weight

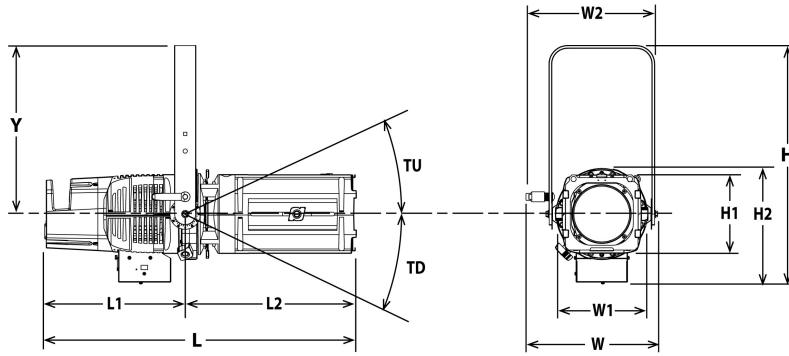

Weight: 9.9 kg (21.8 lbs)

Height	Length	Width	Yoke	Tilt
H= 454 mm (17.9 in)	L= 594 mm (23.4 in)	W= 251 mm (9.9 in)	Y= 301 mm (11.9 in)	TD= 90°
H1= 150 mm (5.9 in)	L1= 268 mm (10.6 in)	W1= 150 mm (5.9 in)		
H2= 218 mm (8.6 in)	L2= 326 mm (12.8 in)			

Shipping

- **Weight :** 11.1 kg (24.4 lbs)
- **Volume :** .06 m³ (1.98 ft³)

Installation

- **Minimum distance to illuminated surface:** 0.5 m (1.6 ft)
- **Operating position:**



Construction

- **Housing:** Die cast aluminium
- **Colour:** Black
- **Cooling:** Low noise variable fan
- **Maximum ambient temperature (Ta):** 40°C (104°F)
- **Maximum case temperature (Tc):** °C (°F)
- **Total heat dissipation:** 461 BTU/h
- **Ingress Protection (IP) rating:** IP20

Electrical compatibility

- 220/230 V - 50 Hz
- 245 V - 50 Hz
- 110/120 V - 60 Hz
- 208 V - 60 Hz
- 220/230 V - 60 Hz
- 100 V - 50 Hz
- 100 V - 60 Hz
- Selector: automatic detection

Power input



- **Type:** removable power cord with Neutrik powerCON TRUE1 TOP connector (included)
- **Cable:** 14 AWG SJ type (UL/CSA)
- **Length:** 1.5 m (4.9 ft)
- **Power connector:** without connector

Power consumption

Voltage	Frequency	Current	Power	Power factor
120 V	60 Hz	1.2 A	135 W	0.94
230 V	50 Hz	0.7 A	130 W	0.81
100 V	60 Hz	1.4 A	135 W	0.93

Power Supply Unit

- **PSU:** Internal - Electronic PSU - Flicker free with PFC
- **Control:** / DMX
- **Protection:** Mains: 2x 6.3A 5x20 T fuses /
- **Power thru:** Neutrik powerCON TRUE1 TOP - Maximum of 22 units (230 V) / 11 units (120 V)

Approvals



Warranty

- **Fixture: 3 years**
- See General Sales Condition on website

Acoustics

- **Noise level:** < 23,5 dB(A)









Model

553CCW	LED 115 W Profile spot - 553CCW Tibo HE - Cool White - 30/45° - North american standard
---------------	---

Options

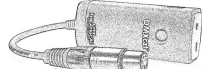
T-RAL9010	White housing (RAL 9010)	
------------------	--------------------------	---

Accessories

D4	Shutter for Tibo series 4 included	
PF100M	135x135mm metal filter holder 1 included	
IS500	Drop-in iris (monoplane) with holder	
SGUT	Universal "M" size gobo-holder (metal, glass, frosted glass)	
DMXcat	Bluetooth DMX/RDM Multifunction test tool - City Theatrical DMXcat®	
872	Doughty "Twenty clamp" with M10 screw/nut for Ø48 to 51mm pipes - SWL: 20Kg - TÜV approved - Poids: 0.25 Kg	
878	Hook clamp 25x6mm with 23mm M10 screw for Ø35 to 50mm pipes - SWL: 11Kg - Poids: 0.46 Kg	
CS2	Safety cable Ø3 mm L= 600mm - SWL: 75 Kg	

• Optics @ 30°

Field lumens	Beam lumens	Efficacy	Beam intensity	CCT	Delta uv
8 420 Lm	4 730 Lm	65 Lm/W	76 200 Cd	5 370 K	0.0033

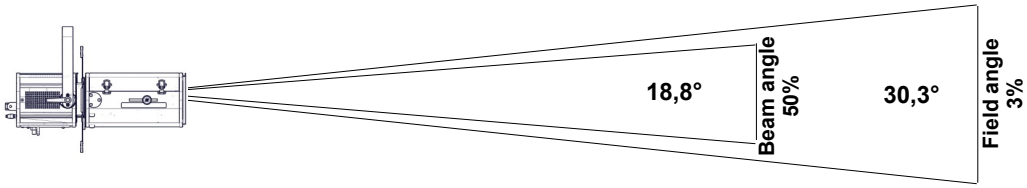

Distance	3 m	5 m	7 m	10 m	12 m	15 m
Field diameter	1,6 m	2,7 m	3,8 m	5,4 m	6,5 m	8,1 m
Illumination	8 500 lux	3 050 lux	1 600 lux	770 lux	530 lux	340 lux
Distance	10 ft	15 ft	25 ft	35 ft	40 ft	50 ft
Field diameter	5,4 ft	8,1 ft	13,5 ft	19 ft	21,7 ft	27,1 ft
Illumination	770 fc	340 fc	130 fc	65 fc	48 fc	31 fc

• Optics @ 38°

Field lumens	Beam lumens	Efficacy	Beam intensity	CCT	Delta uv
9 010 Lm	5 060 Lm	69 Lm/W	53 700 Cd	5 360 K	0.0036

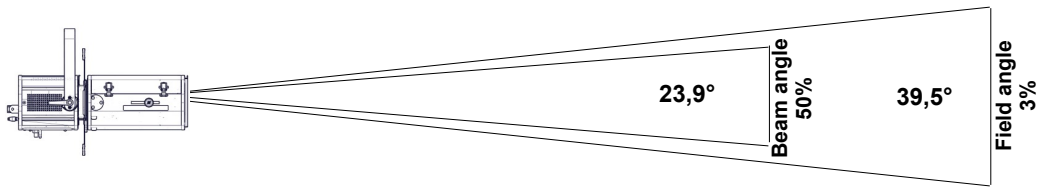

Distance	3 m	5 m	7 m	10 m	12 m	15 m
Field diameter	2,2 m	3,6 m	5 m	7,2 m	8,6 m	10,8 m
Illumination	6 000 lux	2 150 lux	1 100 lux	540 lux	380 lux	240 lux
Distance	10 ft	15 ft	25 ft	35 ft	40 ft	50 ft
Field diameter	7,2 ft	10,8 ft	18 ft	25,1 ft	28,7 ft	35,9 ft
Illumination	540 fc	240 fc	90 fc	44 fc	34 fc	22 fc

• Optics @ 45°

Field lumens	Beam lumens	Efficacy	Beam intensity	CCT	Delta uv
9 420 Lm	5 290 Lm	72 Lm/W	48 300 Cd	5 350 K	0.0034

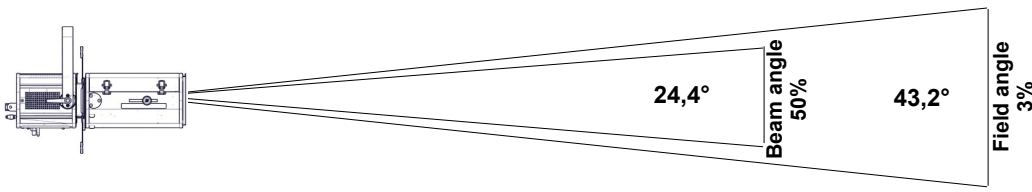

Distance	3 m	5 m	7 m	10 m	12 m	15 m
Field diameter	2,4 m	4 m	5,5 m	7,9 m	9,5 m	11,9 m
Illumination	5 400 lux	1 950 lux	990 lux	490 lux	340 lux	220 lux
Distance	10 ft	15 ft	25 ft	35 ft	40 ft	50 ft
Field diameter	7,9 ft	11,9 ft	19,8 ft	27,7 ft	31,7 ft	39,6 ft
Illumination	490 fc	220 fc	80 fc	40 fc	31 fc	20 fc

• Optics @ 15°

Field lumens	Beam lumens	Efficacy	Beam intensity	CCT	Delta uv
8 570 Lm	4 810 Lm	66 Lm/W	179 700 Cd	5 360 K	0.0028

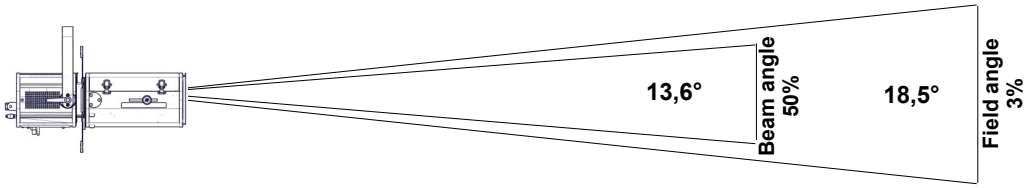

Distance	3 m	5 m	7 m	10 m	12 m	15 m
Field diameter	1 m	1,6 m	2,3 m	3,3 m	3,9 m	4,9 m
Illumination	20 000 lux	7 200 lux	3 700 lux	1 800 lux	1 250 lux	800 lux
Distance	10 ft	15 ft	25 ft	35 ft	40 ft	50 ft
Field diameter	3,3 ft	4,9 ft	8,1 ft	11,4 ft	13 ft	16,3 ft
Illumination	1 800 fc	800 fc	290 fc	150 fc	120 fc	75 fc

• Optics @ 25°

Field lumens	Beam lumens	Efficacy	Beam intensity	CCT	Delta uv
8 640 Lm	4 850 Lm	67 Lm/W	98 600 Cd	5 350 K	0.0032

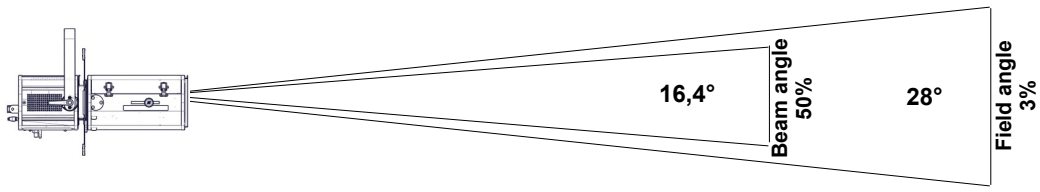

Distance	3 m	5 m	7 m	10 m	12 m	15 m
Field diameter	1,5 m	2,5 m	3,5 m	5 m	6 m	7,5 m
Illumination	11 000 lux	3 950 lux	2 050 lux	990 lux	690 lux	440 lux
Distance	10 ft	15 ft	25 ft	35 ft	40 ft	50 ft
Field diameter	5 ft	7,5 ft	12,5 ft	17,5 ft	19,9 ft	24,9 ft
Illumination	990 fc	440 fc	160 fc	85 fc	65 fc	40 fc

• Optics @ 35°

Field lumens	Beam lumens	Efficacy	Beam intensity	CCT	Delta uv
9 200 Lm	5 160 Lm	71 Lm/W	73 900 Cd	5 330 K	0.0025

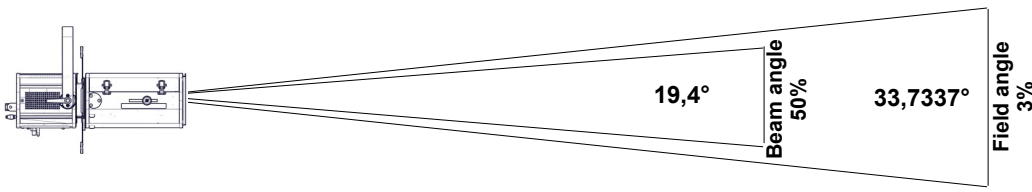

Distance	3 m	5 m	7 m	10 m	12 m	15 m
Field diameter	1,8 m	3 m	4,2 m	6,1 m	7,3 m	9,1 m
Illumination	8 300 lux	3 000 lux	1 550 lux	740 lux	520 lux	330 lux
Distance	10 ft	15 ft	25 ft	35 ft	40 ft	50 ft
Field diameter	6,1 ft	9,1 ft	15,2 ft	21,2 ft	24,3 ft	30,3 ft
Illumination	740 fc	330 fc	120 fc	65 fc	47 fc	30 fc

Light quality report

CCT	DeltaUV	CRI Ra	CRI R9	CQS Qa	TM30-18 Rf	TM30-18 Rg	TLCI	SSI [D5000]
5 160K	0.0035	94	59	94	93	101	90	73

CRI - CIE Colour Rendering Index

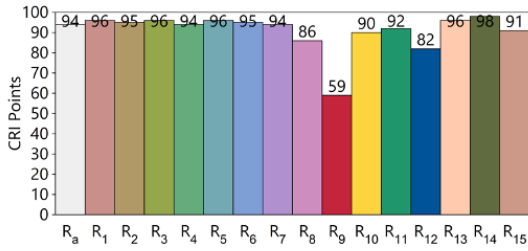

TLCI - Television Lighting Consistency Index

Test : CCT = D5160 (+0.1)
 TLCI-2012 : 90 (D5160)

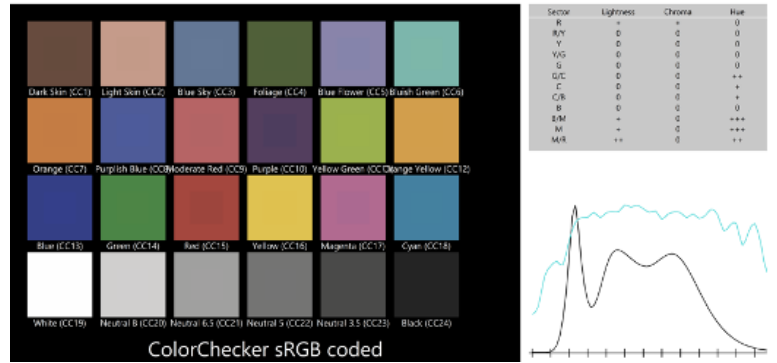

CQS - NIST Colour Quality Scale

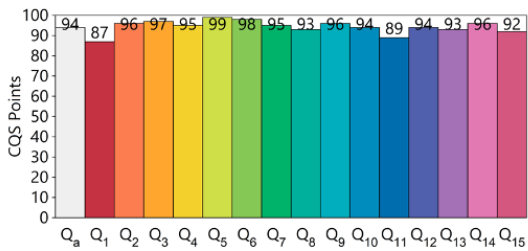

ANSI/IES TM-30-18 Colour Rendition Report

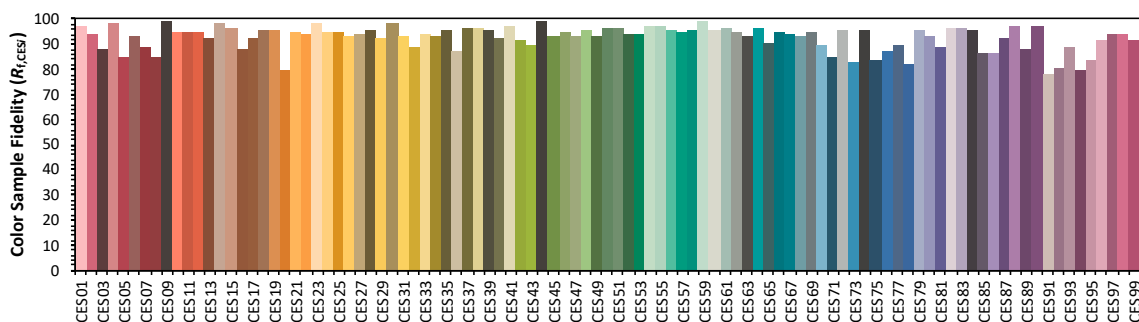
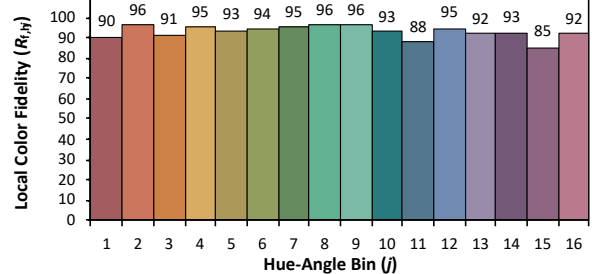
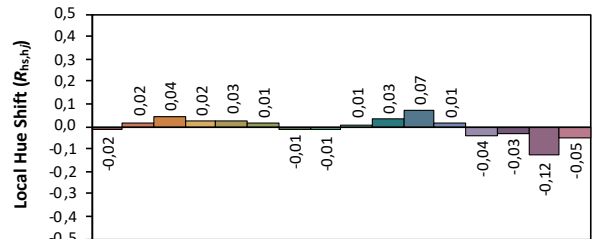
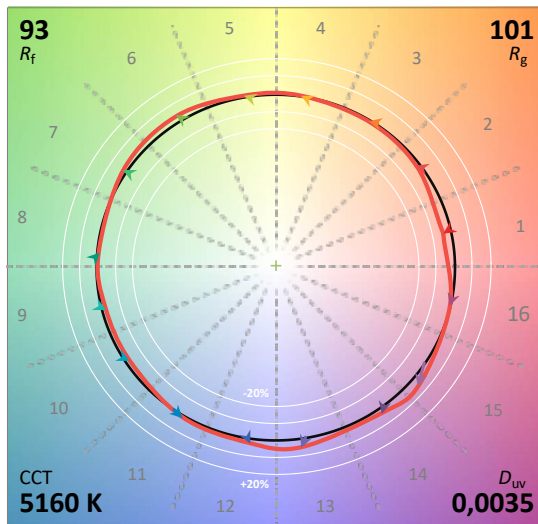
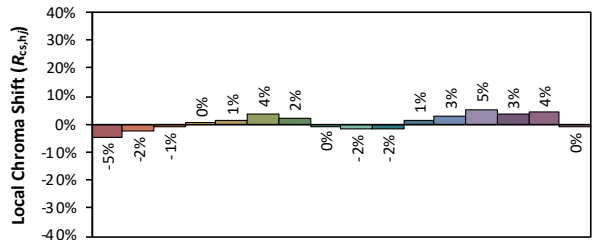
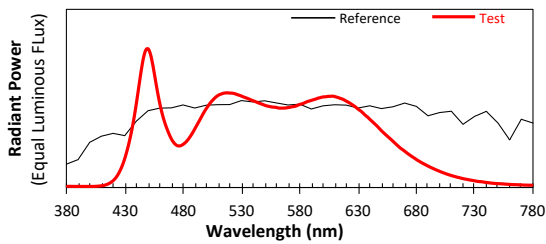

Colours are for visual orientation purposes only. Created with the IES TM-30-18 Calculator Version 2.00