



ADAM A SYN s.r.o.

Jeséniova 3/A

831 01 BRATISLAVA

SLOVAKIA

Tel. +421 2 546 53 511

adamasyn@adamasyn.sk

www.adamasyn.sk



ID System 3



www.adamasyn.sk



PREDSTAVUJEME INOVATÍVNE PÓDIÁ - ID SYSTEM 3

Pódiový ID System 3 bol vyvinutý, aby ponúkol najnovšie javiskové technológie pre javiská a tribúny na celom svete pre interiérové a exteriérové použitie. Vďaka kreatívnym a inovovaným nápadom a zručnostiam ste schopní postaviť flexibilné mobilné stavby, open air pódia, platformové systémy pre podujatia, divadelné pódia a prezentačné expo priestory každej výšky a veľkosti.

ID System 3 spĺňa požiadavky podľa normy DIN-EN 13814 pri zaťažení 500 Kg / m² a bezpečnostným faktorom do 750 Kg / m². Prednosťou ID System 3 je vysoká kvalita výrobkov. Je charakteristický detailmi a vylepšeniami, ktoré ho posunuli pred konkurenciu.

Možnosti využitia sortimentu : pódiové konštrukcie, konštrukcie tribún, stavba javiskových dekorácií, výstavba podláh pre výstavníky a expozície. Mobilné pódia, prenájom pódii, systémy platform pre podujatia, mobilné terasy, eventy a technologické stavby.

Poslednou novinkou je, že naša kompaktná, stabilná a ľahšia pódiová doska je plne kompatibilná s doskami NIVTEC. Spolu s novým inovovaným stavebným systémom lešenia môžete ušetriť náklady na prepravu a skladovanie.

Informácie o našej spoločnosti nájdete na zadnej strane tejto brožúry

Adam Pastorek

majiteľ spoločnosti

Malé veci robia dokonalosť, ale dokonalosť
nie je vôbec malá vec.

DETAIL ZÁMKOV A INOVATÍVNEHO RIEŠENIA UCHYTENIA TRUBIEK

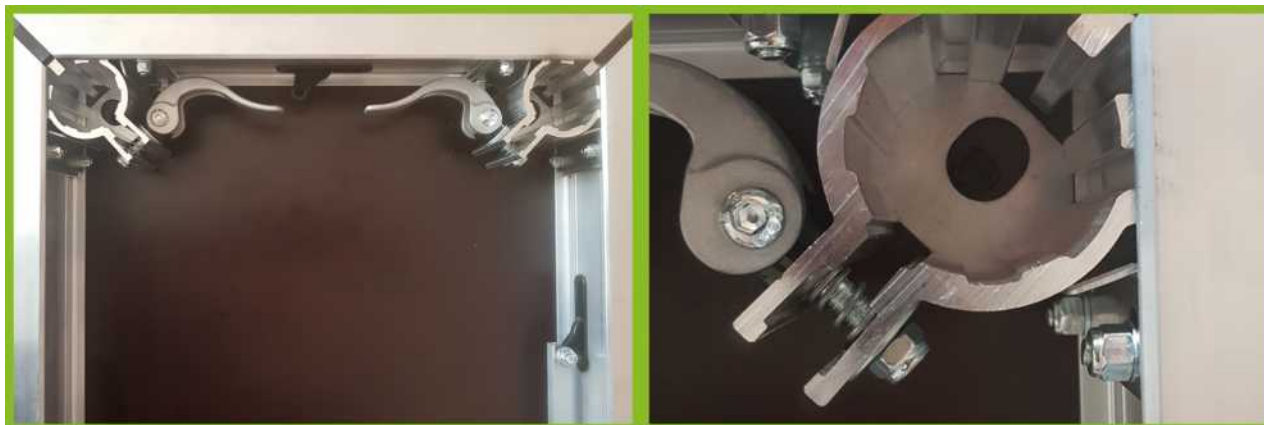

DETAIL UCHYTENIA NOHY



RE: ID System 3 outdoor, odolná, protišmyková čierna preglejka, hrúbka 12mm.



PODLAHY PRE KONŠTRUKCIE PÓDIÍ

Objednávacie číslo L (m) W (m) H (m) Hmotnosť (kg)

01 - OBDĹŽNIKOVÁ DOSKA



ID-SY-3.0200 100 03	2	1	0,9	34.0
ID-SY-3.0150 100 03	1,5	1	0,9	
ID-SY-3.0200 050 03	2	0,5	0,9	

ČIERNY POVRCH SO ZÁTKOU



ID-SY-3.0200 050 03	2	0,5	0,9	34.0
ID-SY-3.0150 050 03	1,5	0,5	0,9	
ID-SY-3.0100 050 03	1	0,5	0,9	

ŠTVORCOVÁ DOSKA

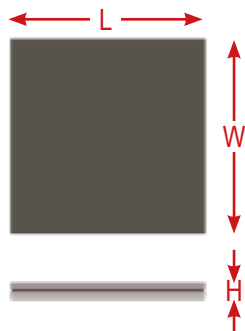

ID-SY-3.0 100 100 03	1	1	0,9	16.5
ID-SY-3.0 050 050 03	0,5	0,5	0,9	16.5

PODLAHY PRE KONŠTRUKCIE PÓDIÍ

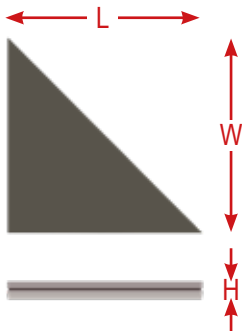
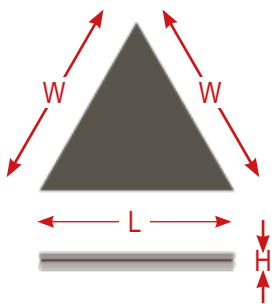
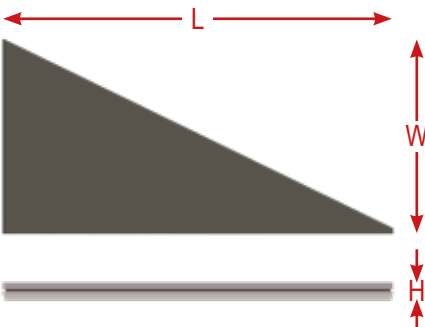
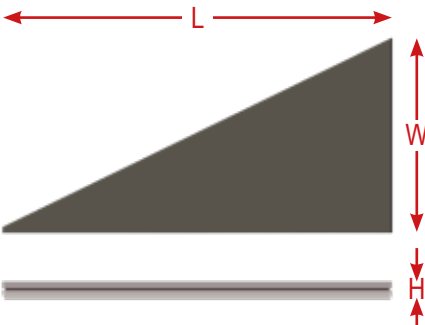
	Objednávacie číslo	L (m)	W (m)	H (m)	Hmotnosť (kg)
TROJUHOĽNÍKOVÁ DOSKA 45° 	ID-BU- U 100 100 45gr	1.0	1.0	0.09	
	ID-BU- B 100 100 45gr				
TROJUHOĽNÍKOVÁ DOSKA 60° 	ID-BU- U 100 100 60gr	1.0	1.0	0.09	
	ID-BU- B 100 100 60gr				
	ID- RE -TR 100 100 60gr				
	ID- SY -TR 100 100 60gr				
TROJUHOĽNÍKOVÁ DOSKA 26.7° ĽAVÁ 	ID-BU- U 200 100 26,5L	2.0	1.0	0.09	
	ID-BU- B 200 100 26,5L				
	ID- RE -TR200 100 26,5L				
TROJUHOĽNÍKOVÁ DOSKA 26.7° PRAVÁ 	ID-BU- U 200 100 26,5R	2.0	1.0	0.09	
	ID-BU- B 200 100 26,5R				
	ID- RE -TR200 100 26,5R				

U: Povrch neupravený, drevená platňa, hrúbka 12mm..

B: Čierny povrchový náter, drevená platňa, hrúbka 12mm.

RE: ID System 3 outdoor, odolná, protišmyková čierna preglejka, hrúbka 12mm.

SY: ID System 3 Profiline s uzamykaním.

PODLAHY PRE KONŠTRUKCIE PÓDIÍ

LICHOBEŽNÍK

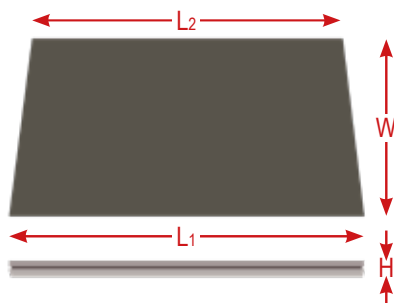

Objednávacie číslo	L (m)	W (m)	H (m)	Hmotnosť (kg)
ID-RE 7TRAPEZIOD	2.0/1.7	1.0	0.09	
ID-RE 6TRAPEZIOD	1.7/1.5	1.0	0.09	
ID-RE 5TRAPEZIOD	1.5/1.2	1.0	0.09	
ID-RE 4TRAPEZIOD	1.2/0.9	1.0	0.09	
ID-RE 3TRAPEZIOD	0.9/0.7	1.0	0.09	
ID-RE 2TRAPEZIOD	0.7/0.4	1.0	0.09	
ID-RE 1TRAPEZIOD	0.4/0.2	1.0	0.09	

Používa sa pre paluby so 4 nohami ako prolyte a 2m

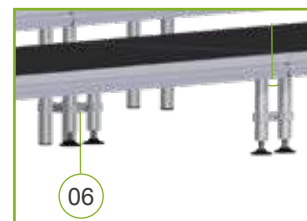

ALU. NOHY Ø48.3 X 4mm PRE ZÁKLADY POD KONŠTRUKCIOU

Objednávacie číslo	L (mm)	W (mm)	H (m)	Hmotnosť (kg)
--------------------	--------	--------	-------	---------------

02 - NOHA STANDARD

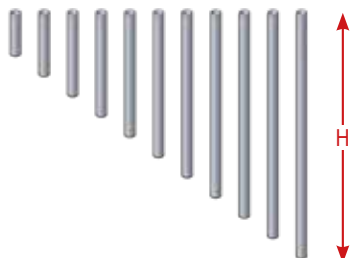

ID-PRO-20			0.2	0.30
ID-PRO-40			0.4	0.60
ID-PRO-60			0.6	0.90
ID-PRO-80			0.8	1.20
ID-PRO-100			1.0	1.50
ID-PRO-120			1.2	1.80

03 - NOHA S ADAPTÉROM

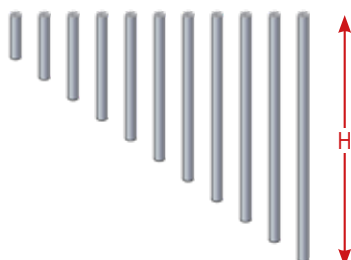

ID-PRO-A-20			0.2	0.60
ID-PRO-A-40			0.4	0.90
ID-PRO-A-60			0.6	1.20
ID-PRO-A-80			0.8	1.50
ID-PRO-A-100			1.0	1.80
ID-PRO-A-120			1.2	2.10

ALU. NOHY Ø48.3 X 4mm PRE ZÁKLADY POD KONŠTRUKCIU

	Objednávacie číslo	L (mm)	W (mm)	H (m)	Weight (kg)
	ID-PRO-S-20			0.2	1.00
	ID-PRO-S-40			0.4	1.30
	ID-PRO-S-60			0.6	1.60
	ID-PRO-S-80			0.8	1.90
	ID-PRO-S-100			1.0	2.20
	ID-PRO-S-120			1.2	2.50

05 - TELESKOPICKÁ NOHA



TILE-40-60

TILE-60-100

TILE-80-140

06 - ROLLING RISER SET



ID-Rolling Set

40

3.5

60

VIAC INFORMÁCIÍ O SVORKÁCH NÁJDETE NA STRANE 15

07 - SVORKA NOHA - NOHA

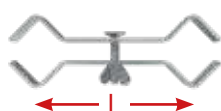

ID-LE2 110 110

0.87

ID-LE2 150 150

0.92

08 - 4 CESTNÁ SVORKA NOHA - NOHA

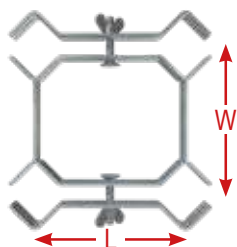

ID-LE4 110 110 150

1.90

ID-LE4 150 150 150

2.01

07 - DECK - DECK SVORKA



ID-DD 110

0.44



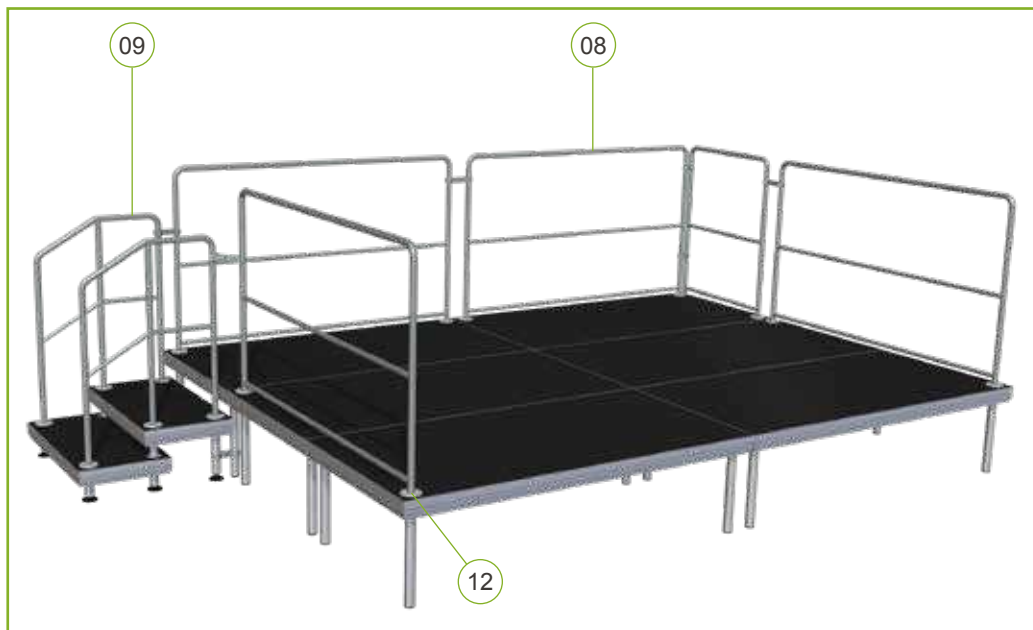

ZÁBRADLIA PRE KONŠTRUKCIU PÓDIÍ

	Objednávacie číslo	L (m)	H ₁ (m)	H ₂ (m)	Hmotnosť(kg)
09 - ŠTANDARDNÉ BEZPEČNOSTNÉ ZÁBRADLIE	ID-035 100	0.35	1.00	1.00	
	ID-085 100	0.85	1.00	1.00	
	ID-135 100	1.35	1.00	1.00	
	ID-185 185	1.85	1.85	1.00	





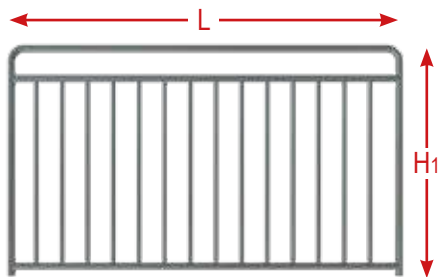

BEZPEČNOSTNÉ ZÁBRADLIE PRE DETI	ŠTART	ID-035 CHANGE	0.35	1.10	
		ID-085 CHANGE	0.85	1.10	
		ID-135 CHANGE	1.35	1.10	
		ID-185 CHANGE	1.85	1.10	
		ID-207 CHANGE	2.07	1.10	

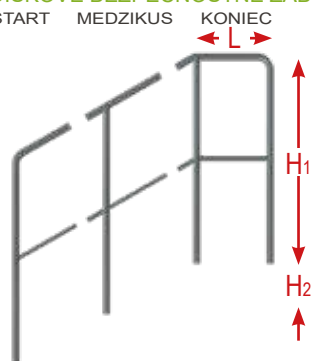



SCHODISKOVÉ BEZPEČNOSTNÉ ZÁBRADLIE	ŠTART	ID012-ST 035	0.35	1.00	0.20
	MEDZIKUS	ID022-ST 035	0.35	1.00	0.20
	UKONČENIE	ID052-ST 035	0.35	1.00	0.20



ZÁBRADLIA PRE KONŠTRUKCIU PÓDIÍ

	Objednávacie číslo	L (m)	H ₁ (m)	H ₂ (m)	Hmotnosť (kg)
10 - RÚRKA Ø48mm PRE SCHODY 		0.15			
		0.17			
		0.20			
.....					
11 - Pero Ø39mm PRE SCHODY 					
.....					
12 - Pero Ø26mm PRE BEZPEČNOSTNÉ ZÁBRADLIE 					
.....					
12A - ADAPTÉR Ø48.3mm 		0.75			0.40

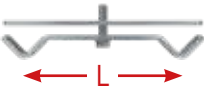
VIAC INFORMÁCIÍ O SVORKÁCH NÁJDETE NA STRANE 15

13 - BEZPEČNOSTNÁ SVORKA ZÁBRADLIA 	ID-SA 110	0.11			0.94
	ID-SA 150	0.15			1.10
.....					
14 - ROHOVÁ SVORKA 	ID-CO 50	0.05			0.43

TRANSPORTNÝ VOZÍK PRE 6 DOSIEK



VOZÍK PRE BEZPEČNOSTNÉ ZÁBRADLIE

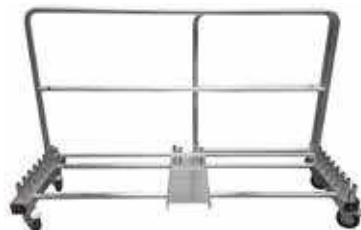

NÍZKY VOZÍK





PREPRAVNÝ VOZÍK S POPRUHMI



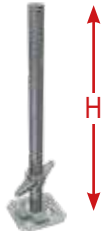

PÓDIUM NA LEŠENÁRSKEJ KONŠTRUKCII

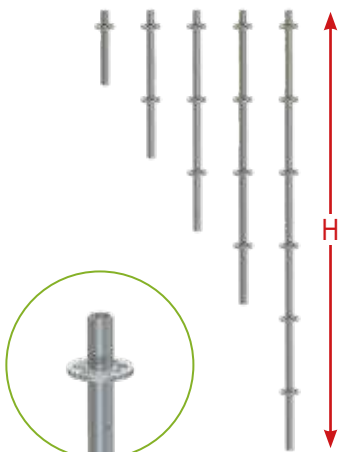
	Objednávacie číslo	L (m)	W (m)	H (m)	Hmotnosť (kg)
15 - NASTAVITEĽNÁ ZÁKLADNÁ DOSKA 	0001/020			0.20	2.00
	0001/030			0.30	2.50
	0001/040			0.40	3.00
	0001/050			0.50	3.60
	0001/060			0.60	4.20
	0001/080			0.80	5.30
				
16 - PRÍRUBA 	0002/000				1.60
.....					
17 - ŠTANDARD BEZ ZÁTKY 	0005/025			0.25	1.60
	0005/050			0.50	2.30
	0005/100			1.00	4.50
	0005/150			1.50	6.80
	0005/200			2.00	9.10
	0005/250			2.50	11.40
	0005/300			3.00	13.60

PÓDIUM NA LEŠENÁRSKEJ KONŠTRUKCII

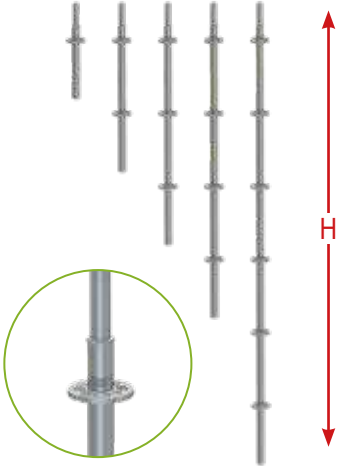
	Objednávacie číslo	L (m)	W (m)	H (m)	Hmotnosť (kg)
ŠTANDARD BEZ ZÁTKY 	0003/050			0.45	3.20
	0003/100			1.00	5.40
	0003/150			1.50	7.80
	0003/200			2.00	10.00
	0003/300			3.00	14.60

18 - PRIEČNIK



0006/045	0.45			2.20
0006/073	0.73			3.20
0006/103	1.03			4.30
0006/109	1.09			4.50
0006/207	2.07			8.00

19 - ZVISLÉ DIAGONÁLNE VZPERY

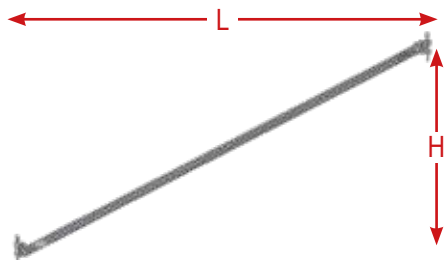

0013/103	1.03	0.50		4.80
0012/103	1.03	1.00		5.60
0011/103	1.03	1.50		6.70
0010/103	1.03	2.00		7.90
0013/207	2.07	0.50		7.30
0012/207	2.07	1.00		7.80
0011/207	2.07	1.50		8.50
0010/207	2.07	2.00		9.40



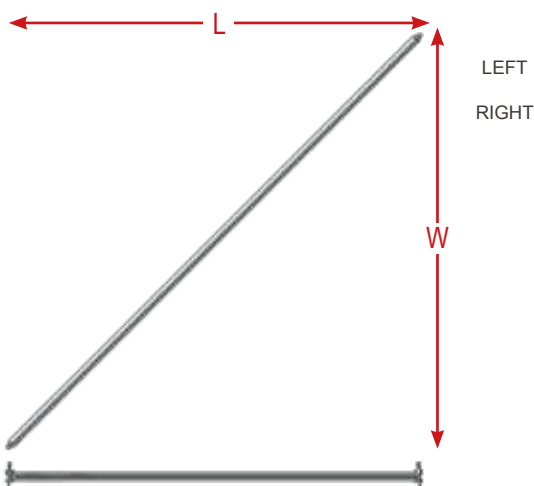

20 - HORIZONTÁLNE DIAGONÁLNE VZPERY

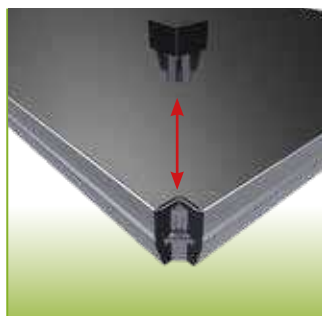

0015/207	1.03	1.03		5.80
0015/207	2.07	2.07		10.70
0015/600	2.07	1.03		8.90
0015/601	2.07	1.03		8.90



PÓDIUM NA LEŠENÁRSKEJ KONŠTRUKCII

	Objednávacie číslo	L (m)	W (m)	H (m)	Hmotnosť (kg)
21 - NOSNÍK  	0083/050				
	0083/100				
	0083/150				
	0083/200				
	0084/010	1.04			
	0084/020	2.07			
22 - OBDĹŽNIKOVÁ DOSKA - ADAPTÉRY PRE NOHY DOOKOLA LEN S MATICAMI  	0084/110	1.03	0.52	0.09	
	0084/125	1.03	1.03	0.09	
	0084/115	1.55	0.52	0.09	
	0084/120	2.07	0.52	0.09	
	0084/135	2.07	1.03	0.09	

PÓDIUM NA LEŠENÁRSKEJ KONŠTRUKCII

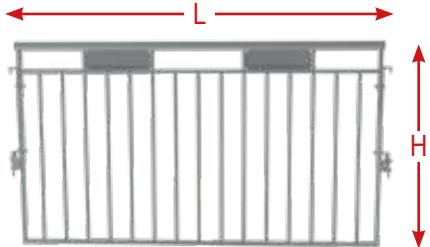
	Objednávacie číslo	L (m)	W (m)	H (m)	Hmotnosť (kg)
23 - ZÁBRADLIE S BEZPEČNOSTNÝMI ZVODIDLAMI 	0050/050				
	0051/052	1.03		1.10	
	0050/100				
	0051/403	1.03		1.10	15.6
	0050/150				
	0051/155	1.55		1.10	
	0050/200				
	0051/420	2.07		1.10	31.2



PÓDIUM NA LEŠENÁRSKEJ KONŠTRUKCII

	Objednávacie číslo	L (m)	W (m)	H (m)	Hmotnosť (kg)
24 - OCEĽOVÁ PALUBA 	0032/100	1.00	0.32		7.70
	0032/103	1.03	0.32		
	0032/150	1.50	0.32		
	0032/200	2.00	0.32		
	0032/207	2.07	0.32		16.5
				
26 - ZAMYKACÍ KLIP PALUBY - NOSNÍK	ID-DB-CLIP				0.15

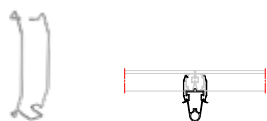

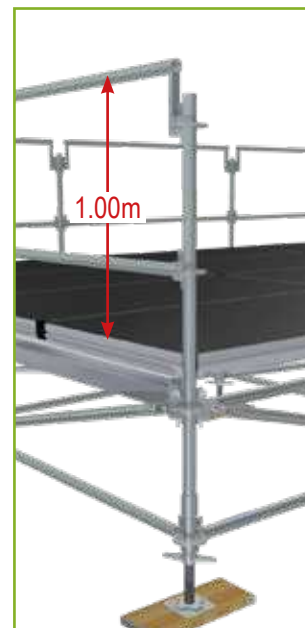



PÓDIUM NA LEŠNÁRSKEJ KONŠTRUKCII

	Objednávacie číslo	L (m)	W (m)	H (m)	Hmotnosť (kg)
27 - POZDĹŽNY NOSNÍK	S0032/103	1.03	0.32		7.70
	S0032/207	2.07	0.32		16.5
28 - ZVÝŠENÉ ZÁBRADLIE	S00??/010	1.03		0.20	
	S00??/020	2.07		0.20	
POZDĹŽNY NOSNÍK	S0050/050	0.94	0.64	0.50	11.0
	S0050/100	1.44	0.64	1.00	14.8
	S0050/150	1.94	0.64	1.50	25.3
OCHRANNÉ ZÁBRADLIE	S0051/305	1.03		0.50	16.3
	S0051/310	1.57		1.00	23.6
	S0051/315	2.57		1.50	36.5
	S0051/320	2.57		2.00	37.6

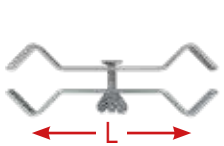
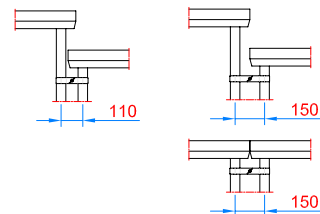
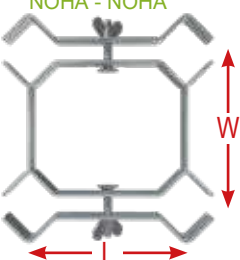
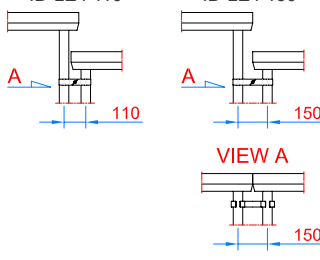
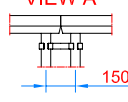
SVORKY PRE KONŠTRUKCIU GALÉRIE

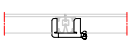
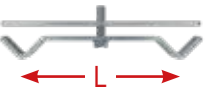
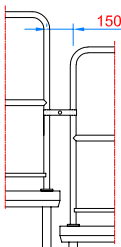
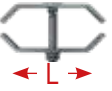
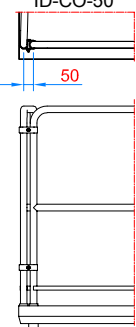
	Situovanie	Objednávacie číslo	L (mm)	W (mm)	Hmotnosť (kg)
* 04 - SVORKA NOHA - NOHA	ID-LE2 110	ID-LE2 150	ID-LE2 110	110	0.87
			ID-LE2 150	150	0.92
* 05 - 4 CESTNÁ SVORKA NOHA - NOHA	ID-LE4 110	ID-LE4 150	ID-LE4 110	110	1.90
			ID-LE4 150	150	2.01
					
* 06 - SVORKA DOSKA - DOSKA		ID-DD 110	ID-DD 110		0.15
					
* 13 - BEZPEČNOSTNÁ SVORKA ŽÁBRADLIA	ID-SA 110	ID-SA 150	ID-SA 110	110	0.94
			ID-SA 150	150	1.10
* 14 - ROHOVÁ SVORKA		ID-CO-50	ID-CO 50	50	0.43
					
* * žiarovo zinkovaná oceľ					

Profil drážky umožňuje vkladanie skrutiek resp.matice do profilu.



Hlbšia drážka na boku umožňuje bezproblémové nalepenie suchého zipsu.



Detail riešenia zámku po demontáži. Tlakové body zabezpečujú lepšie zovretie trubky.



ADAM A SYN s.r.o.

Jeséniova 3/A
831 01 BRATISLAVA
SLOVAKIA

Tel: +421(2)54653511

Email: info@adamasyn.sk

Web: www.adamasyn.sk

